

Article number: 0102024

Description: Retaining ring J10 DIN472  
Spring steel

## Measures

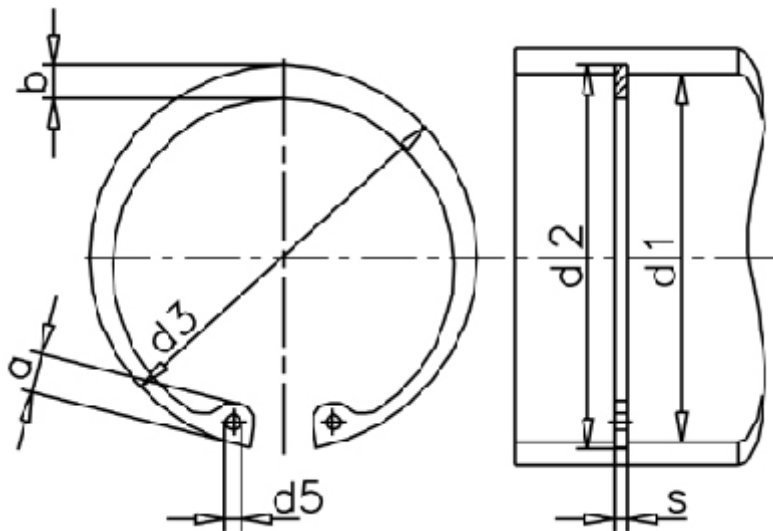

a max	= 3.2	FN kN	= 1.08	t	= 0.20
AN mm <sup>2</sup>	= 6.4	FRg kN	= 2.2	tol	= +0,11
b	= 1.4	FR kN	= 4.0	tol	= +0,36-1,10
d1	= 10	g	= 0.5	tol	= -0.06
d2	= 10.4	K kN-mm	= 19.6	Tong	= ZGJ-1
d3	= 10.80	m min	= 1.10	Weight kg/1000	= 0.26
d5 min	= 1.2	Nominal drive	= 0.6		
Description = J 10		s	= 1.00		